

SA2



**RAFFLES GIRLS' PRIMARY SCHOOL
PRELIMINARY EXAMINATION
MATHEMATICS (PAPER 1)
PRIMARY 6**

Name: _____ ()

Form Class: P6 _____

Math Teacher : _____

Date: 19 Aug 2021

Duration: 1 hour

Your Paper 1 Score (Out of 45 marks)		
Your Paper 2 Score (Out of 55 marks)		
Your Total Score (Out of 100 marks)		
Parent's Signature		

INSTRUCTIONS TO CANDIDATES

1. Do not turn over this page until you are told to do so.
2. Follow all instructions carefully.
3. Answer **ALL** questions and show all working clearly.
4. **NO** calculator is allowed for this paper.

Questions 1 to 10 carry 1 mark each. Questions 11 to 15 carry 2 marks each.
For each question, four options are given. One of them is the correct answer.
Make your choice (1, 2, 3 or 4). Shade your answer (1, 2, 3 or 4) on the OAS provided.
All diagrams are not drawn to scale.

1. Express two million, five hundred and two thousand, two hundred and five as a numeral.

(1) 2 002 705

(2) 2 502 025

(3) 2 502 205

(4) 2 520 250

2. Which of the following is greater than $\frac{4}{7}$?

(1) $\frac{1}{2}$

(2) $\frac{2}{3}$

(3) $\frac{3}{8}$

(4) $\frac{4}{9}$

3.

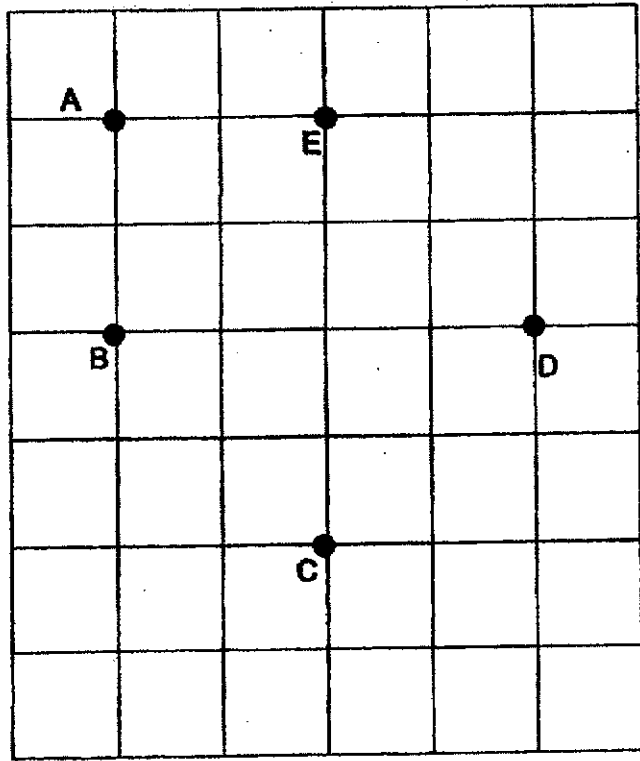

Which point is South-West of Point E?

- (1) A
- (2) B
- (3) C
- (4) D

4. The area of the shaded face of the cuboid is 18 cm^2 . Its length is 4 cm . Find the volume of the cuboid.



- (1) 4.5 cm^3
- (2) 22 cm^3
- (3) 72 cm^3
- (4) 288 cm^3

5. In the figure, EACDF and BDG are straight lines. $\angle ABC = 40^\circ$, $\angle EAB = 110^\circ$ and $\angle FDG = 36^\circ$. Find $\angle CBD$.

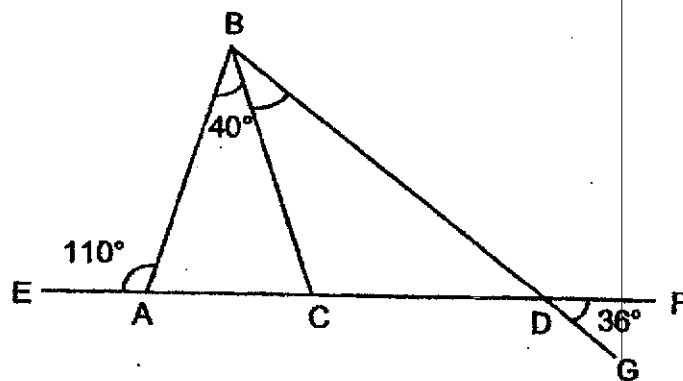

- (1) 34°
- (2) 36°
- (3) 70°
- (4) 74°

6. What is the mass of the watermelon?

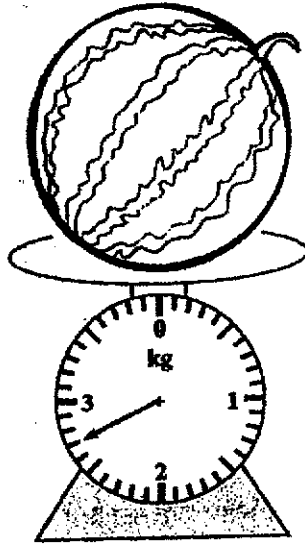

- (1) 2.7 kg
- (2) 2.8 kg
- (3) 3.2 kg
- (4) 3.3 kg

7. The figure consists of a square and an equilateral triangle. Find its perimeter.

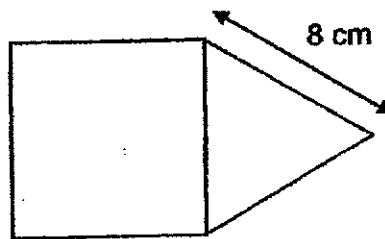

- (1) 40 cm
- (2) 48 cm
- (3) 56 cm
- (4) 96 cm

8. In a library, $\frac{1}{4}$ of the books are magazines. Half of the remaining books are fiction books. What is the ratio of the number of fiction books to the number of magazines?
- (1) 1 : 2
 - (2) 2 : 1
 - (3) 2 : 3
 - (4) 3 : 2
9. Jamie spent 70% of her savings on a laptop and had \$2100 left. How much savings did she have at first?
- (1) \$7000
 - (2) \$4900
 - (3) \$3000
 - (4) \$2100
10. The cost of a pen is $\$n$. A book costs \$6 more than a pen. Express the total cost of 2 books and 3 pens in terms of n .
- (1) $\$(5n - 12)$
 - (2) $\$(5n - 30)$
 - (3) $\$(5n + 12)$
 - (4) $\$(5n + 30)$

11. The price of a bag was \$800 before GST. How much did Mrs. Tan pay for the bag including the 7% GST?

- (1) \$56
- (2) \$744
- (3) \$807
- (4) \$856

12. Richelle had some of 20-cent and 50-cent coins. The total value of the coins was \$40. For every five 20-cent coins, there were two 50-cent coins. How many coins did Richelle have altogether?

- (1) 20
- (2) 40
- (3) 100
- (4) 140

13. Jane baked some butter and chocolate cookies. After eating 7 butter cookies, she found that the number of chocolate cookies left was 3 times the number of butter cookies left. She packed the remaining cookies equally into 9 boxes. Each box contained 16 cookies. How many butter cookies did Jane bake?

- (1) 36
- (2) 43
- (3) 108
- (4) 115

14. By rounding each of the numbers to the nearest whole number, estimate the value of:

$$11.5 \times 8.97 - 4.54$$

- (1) 48
 - (2) 94
 - (3) 103
 - (4) 104
15. Egg tarts are sold in boxes of 2 for \$3. Fruit tarts are sold in boxes of 4 for \$4. Mrs Asfarah wants to buy an equal number of egg tarts and fruit tarts. What is the maximum number of tarts she can buy with \$85?

- (1) 32
- (2) 34
- (3) 64
- (4) 68

Questions 16 to 20 carry 1 mark each. Write your answers in the spaces provided. For questions which require units, give your answers in the units stated. All diagrams are not drawn to scale. Answers in fractions or ratio must be expressed in the simplest form.

16. Fill in the boxes with a correct operation symbol.

$$\begin{array}{c} \boxed{+ , \times} \\ (3 \boxed{} 5 \boxed{} 2) \boxed{} 4 = 68 \end{array}$$

17. Kate painted a picture in 2 h 45 min. She completed her painting at 21 30. What time did she start painting? Give your answer in 12-hour clock.

Ans: _____ p.m.

18. Find the value of $42 \div 4$. Give your answer as a mixed number in its simplest form.

Ans: _____

19. Find the value of $201.4 - 9.86$.

Ans: _____

20.

Day	Mon to Thur	Fri to Sat	Sun
No of hours worked per day	8	5	0

The table shows the number of hours Terry worked in a week delivering parcels. What is the average number of hours he worked per day?

Ans: _____ h

Questions 21 to 30 carry 2 marks each. Show your working clearly in the space provided for each question and write your answers in the space provided. For questions which require units, give your answers in the units stated. All diagrams are not drawn to scale. Answers in fractions or ratio must be expressed in the simplest form.

21. What is the missing number in the box? Give your answer as a fraction in the simplest form.

$$\frac{1}{2} + \boxed{?} = \frac{9}{10} - \frac{1}{5}$$

Ans: _____

22. A wooden plank is 1.08 m long. Mr Amir sawed it into 4 pieces. Each piece was 8 cm longer than the previous piece. What was the length of the shortest piece? Give your answer in cm.

Ans: _____ cm

23. The figure shows two squares. The perimeter of Square B is 12 cm more than the perimeter of Square A. Given that the total perimeter of the two squares is 148 cm, find the value of m .

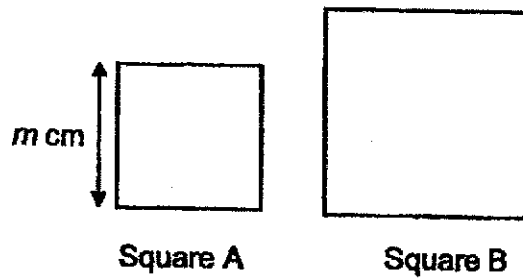

Ans: _____

24. Mariko could pack some pens into bags of 8 or 12 with no remainder. When she packed the pens into bags of 10, she needed 4 more pens. What was the smallest possible number of pens that Mariko had?

Ans: _____

25. A piece of paper in the shape of an isosceles triangle is folded along the dotted lines. Find $\angle x$.

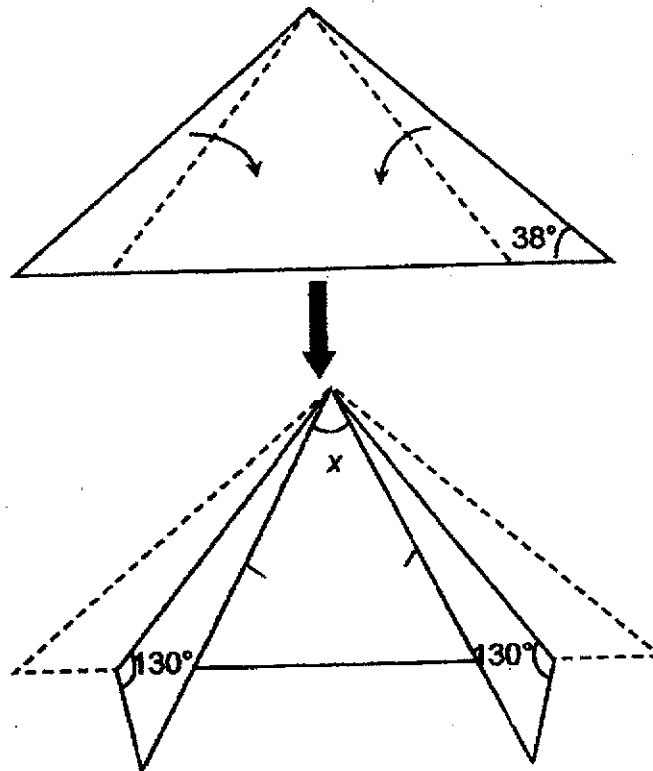

Ans: _____

26. Mary wanted to buy 50 lemons. The lemons were sold either for 95 cents each or at \$3 for a bag of 4 lemons. What was the least amount of money that Mary would need to pay for the lemons?

Ans: \$ _____

27. PQRS is a rectangle and PUS is a triangle. The area of triangle PTS is 12 cm^2 . Find the area of the PQRTUS.

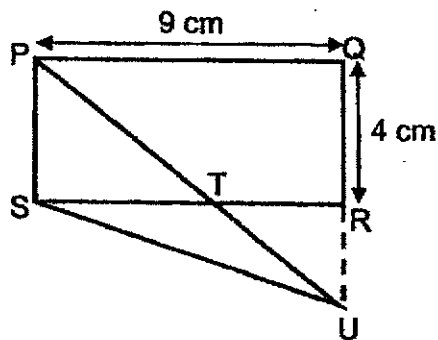

Ans: _____ cm^2

28. The table shows the rental rates of bicycles.

	Adult	Children
Rate	\$10 per hour or part thereof	\$5 per hour or part thereof

Mr Chandran paid \$60 to rent a bicycle for himself and a bicycle each for his 2 children. What was the maximum number of hours they had rented their bicycles?

Ans: _____ h

29. The graph shows the mass of durians bought by the different families.

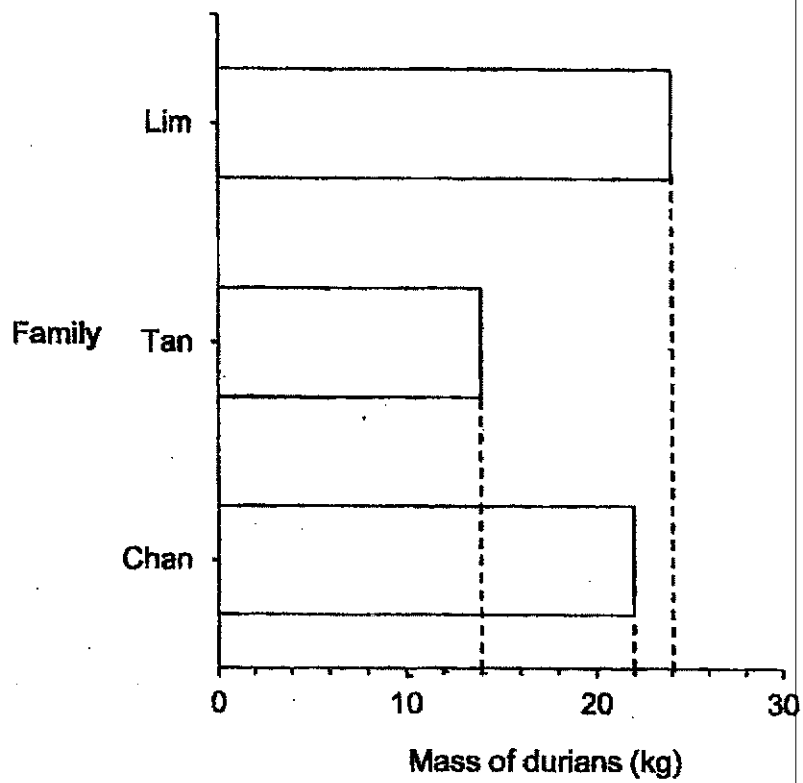

The 3 families paid a total of \$1200 for the durians they bought. How much did 1 kg of durian cost?

Ans: \$ _____

30.

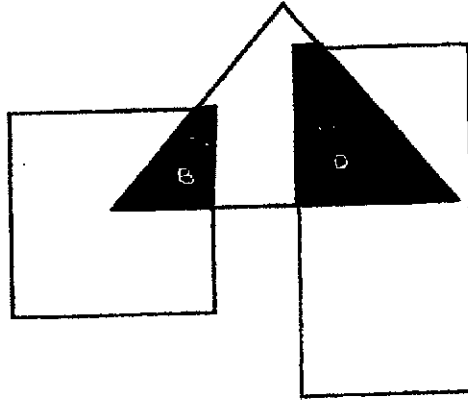

The ratio of the area of the square to the area of the triangle to the area of the rectangle is $5 : 8 : 20$. If $\frac{1}{5}$ of the rectangle and $\frac{3}{4}$ of the triangle is shaded, what fraction of the figure is shaded? Give your answer in the simplest form.

Ans: _____

End of Paper
☺ Please check your work carefully ☺



**RAFFLES GIRLS' PRIMARY SCHOOL
PRELIMINARY EXAMINATION
MATHEMATICS (PAPER 2)
PRIMARY 6**

Name: _____ ()

Form class: P6 _____

Math Teacher : _____

Date: 19 Aug 2021

Duration: 1 h 30 min

INSTRUCTIONS TO CANDIDATES

1. Do not turn over this page until you are told to do so.
2. Follow all instructions carefully.
3. Answer **ALL** questions and show all working clearly.
4. The use of calculator is allowed for this paper.

Questions 1 to 5 carry 2 marks each. Show your working clearly in the space provided for each question and write your answers in the spaces provided. Figures are not drawn to scale.

For questions which require units, give your answers in the units stated. Answers in fractions or ratio must be expressed in the simplest form. (10 marks)

1. Ali's salary was \$4800 in June. His salary was \$3840 in July. What was the percentage decrease in his salary?

Ans : _____ % [2]

2. The line graph shows the amount of money Siti had in her bank on the last day of every month.

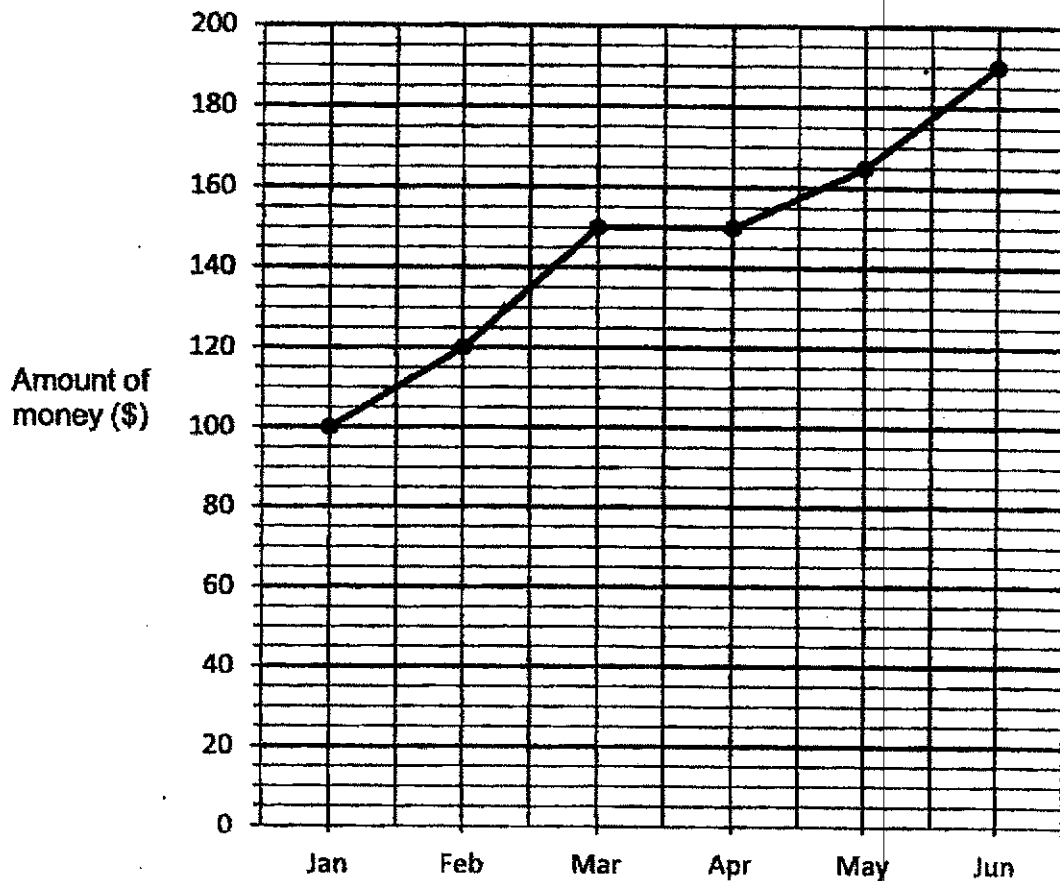

Every month, Siti would deposit some money into the bank without making any withdrawal.

- (a) In which month did she not make any deposit?
(b) In which month did she deposit the most amount of money?

Ans : (a) _____ [1]

(b) _____ [1]

3. In the figure, ABCD is a parallelogram. BCG and EFG are straight lines, AE = AD, $\angle EBG = 52^\circ$ and $\angle EFD = 98^\circ$. Find $\angle DEF$.

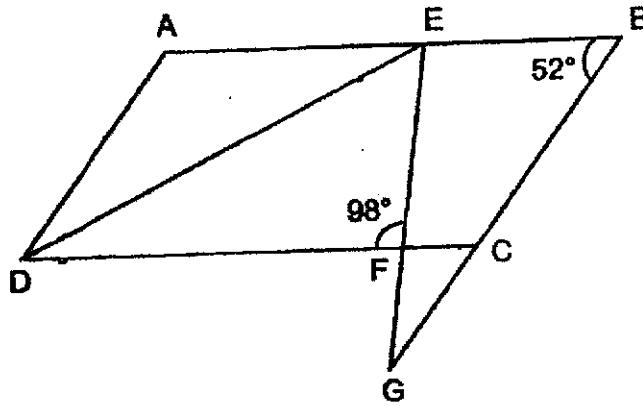

Ans : _____° [2]

4. Jaz, Kumar and Farah shared the cost of a laptop. Jaz paid $\frac{1}{4}$ of the total share of Kumar and Farah. Kumar paid $\frac{1}{2}$ of the total cost of the laptop. Farah paid \$186 more than Jaz. How much did the laptop cost?

Ans : \$ _____ [2]

5. The figure is made up of two rectangles ABCD, EFGH and a triangle BCJ.
 $AD = 6\text{ cm}$, $AB = 8y\text{ cm}$ and $BJ = CJ$.

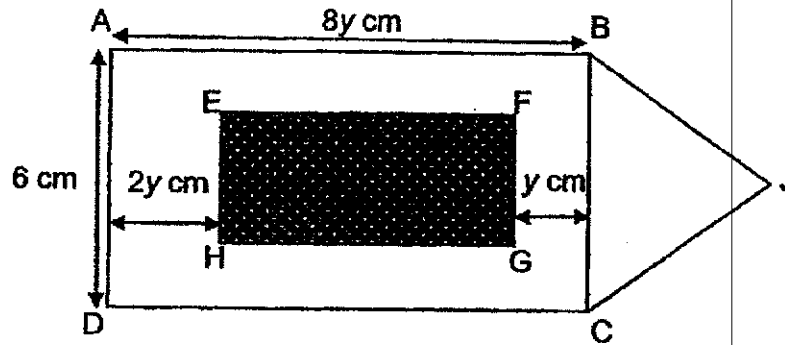

Each of the statements below is either true, false or not possible to tell from the information given. For each statement, put a tick(✓) to indicate your answer.

Statement	True	False	Not possible to tell
(a) The area of rectangle ABCD is $48y\text{ cm}^2$.			
(b) The area of the shaded area EFGH is $33y\text{ cm}^2$ lesser than the area of ABCD.			
(c) The perimeter of ABJCD is $(16y + 18)\text{ cm}$.			

[2]

For questions 6 to 17, show your working clearly in the space provided for each question and write your answers in the spaces provided.
 The number of marks available is shown in the brackets [] at the end of each question or part-question.
 Figures are not drawn to scale.
 Answers in fractions or ratio must be expressed in the simplest form. (45 marks)

6. The figure shows a square garden with a footpath. The area of the garden is 100 m^2 . The width of the footpath is 2 m . Mr Chan wants to place 128 round stones each with a diameter of 0.5 m on the footpath. The stones cannot overlap one another. Use the calculator value of π to find the area of the footpath not covered by the stones in square metres.
 Round your answer to 1 decimal place.

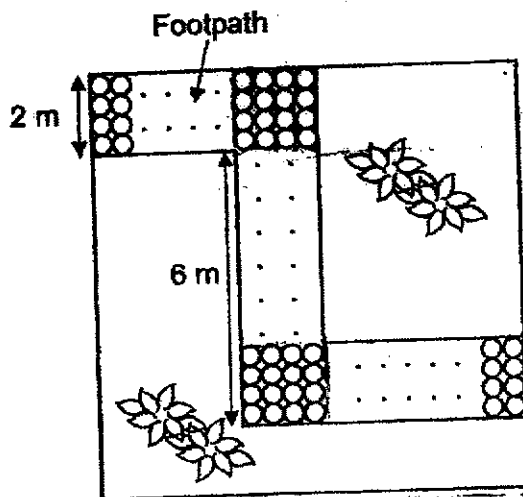

Ans : _____ [3]

7. In the figure, PQRS is a parallelogram. TXRV and TPS are straight lines..
 TU is parallel to PQ, $\angle UTX = 79^\circ$, $\angle QRV = 143^\circ$ and $\angle RSV = 21^\circ$.
- (a) Find $\angle XQR$.
- (b) Find $\angle SVR$.

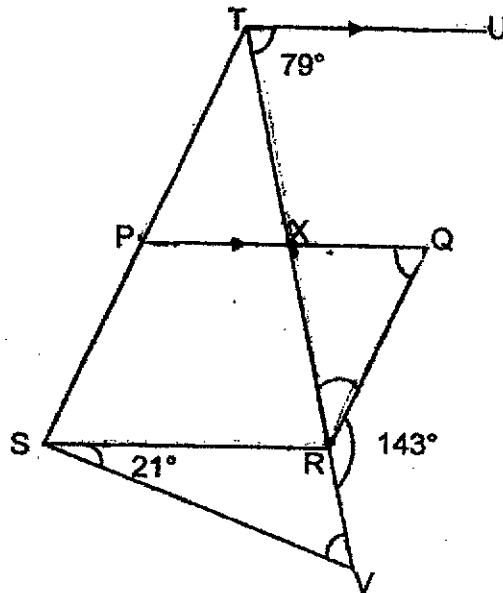

Ans: (a) _____ [1]
 (b) _____ [2]

8. Mary decorated her house with balloons for a party. She arranged 14 balloons hanging on the rope from one end of the wall to another end of the wall as shown in Figure 1.

The balloons were arranged at an equal distance of 30 cm apart.

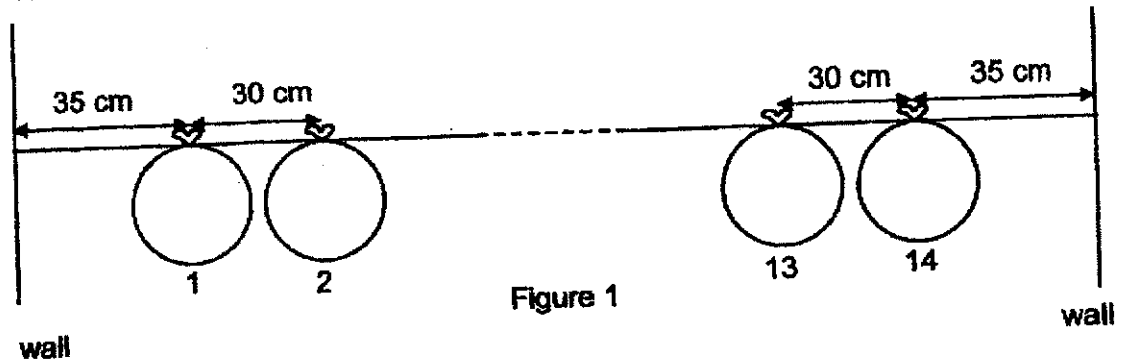

On the actual day of the party, she burst 4 of the balloons and had to rearrange the balloons with a new gap as shown in Figure 2.

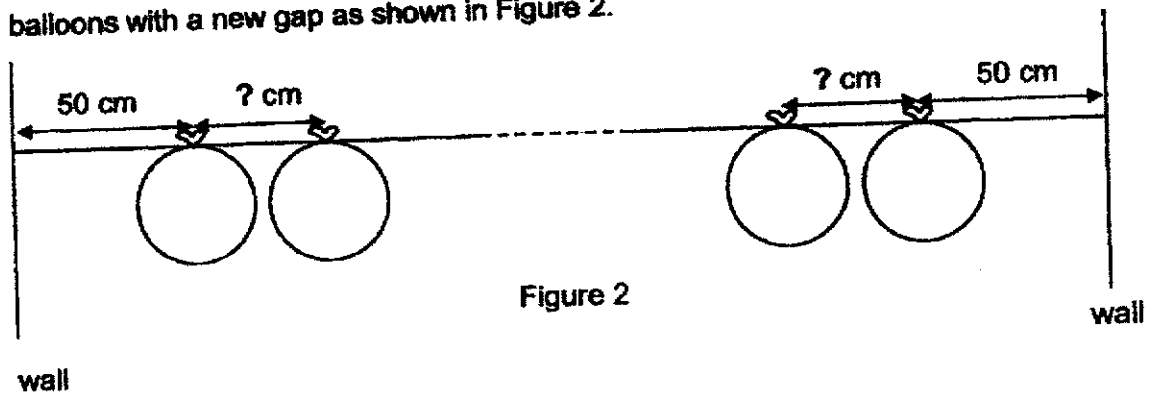

What is the length of the new gap between any two consecutive balloons?

Ans : _____ [3]

9. The mass of a volleyball is 0.21 kg more than a tennis ball. The mass of 2 volleyballs is the same as the mass of 9 tennis balls. Find the total mass of 1 volleyball and 1 tennis ball in grams.

Ans : _____ [3]

10. Tom spent \$1440 of his salary on food, gave 40% of the remaining money to his parents and saved the rest. He saved 15% of his salary every month.
- (a) What percentage of his salary did he give to his parents?
 - (b) What was Tom's monthly salary?

Ans: (a) _____ [1]

(b) _____ [2]

11. Two printing machines, A and B, were used to print the pages of some books. Machine A can print 110 pages per minute. Machine B can print 2 pages per second.

(a) What is the difference in the number of pages printed by the machines in 1 minute?

(b) Both machines were used to print the pages of some books. Machine A started printing at 8 a.m. Machine B started printing at 8.45 a.m., while Machine A was still printing. At what time did both machines print the same number of pages?

Ans: (a) _____ [1]

(b) _____ [3]

12. The bar graph shows the number of visitors to an art gallery.

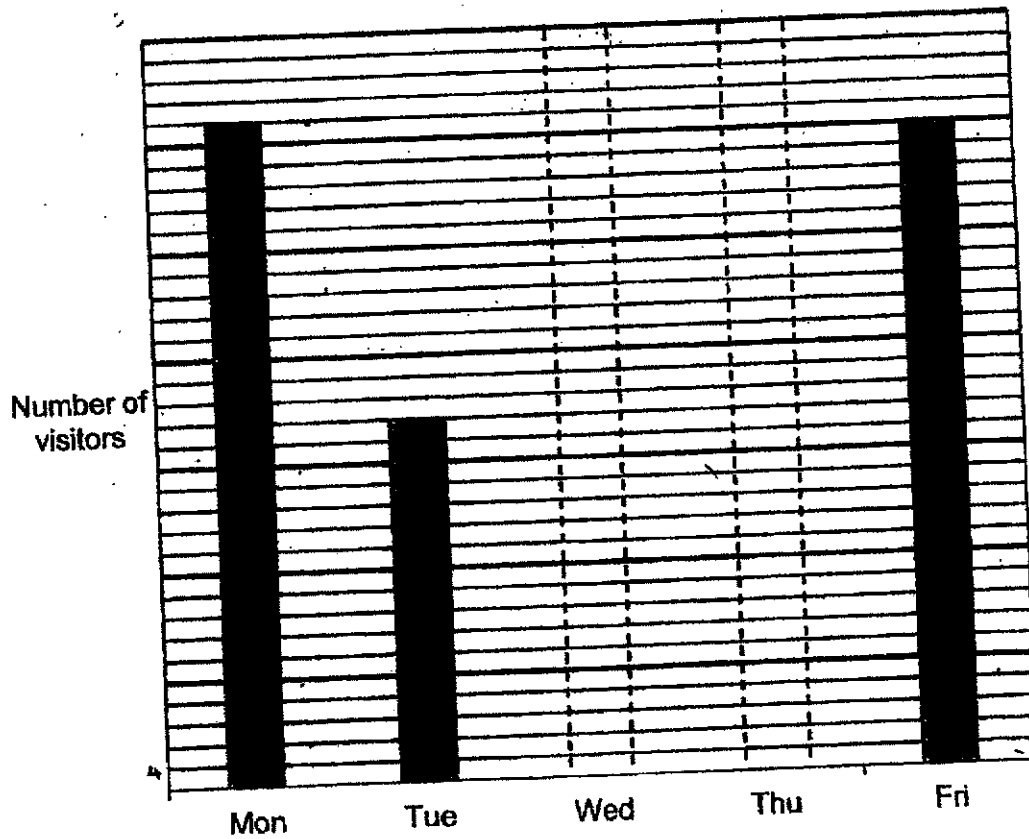

- (a) There were 56 more visitors on Monday than Tuesday. How many visitors were there at the gallery on Monday?
- (b) The average number of visitors at the gallery for Wednesday to Friday was 75. There were more visitors on Wednesday than Thursday. Given that the difference between the number of visitors on Wednesday and Thursday was the smallest possible number, what was the number of visitors on Thursday?

Ans: (a) _____ [2]

(b) _____ [2]

13. Tank X is 30 cm long, 10 cm wide and 20 cm high. It is $\frac{5}{8}$ filled with water. Some water is poured into an empty cubical Tank Y until it is completely filled. The length of Tank Y is 15 cm.

- (a) What is the volume of water in Tank X at first? Give your answer in cm^3 .
(b) What is the volume of water left in Tank X? Give your answer in litres.

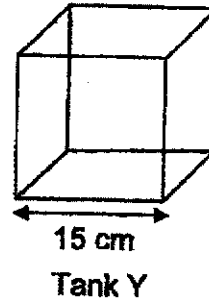
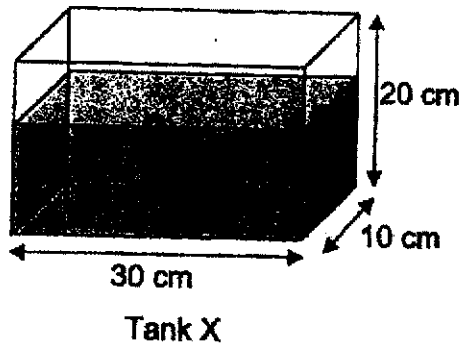

Ans: (a) _____ [2]

(b) _____ [2]

14. ABCD is a square. BFE and AFC are straight lines. $BC = BE$ and $\angle EAF = 18^\circ$.

(a) Find $\angle ABE$.

(b) Find $\angle ECD$.

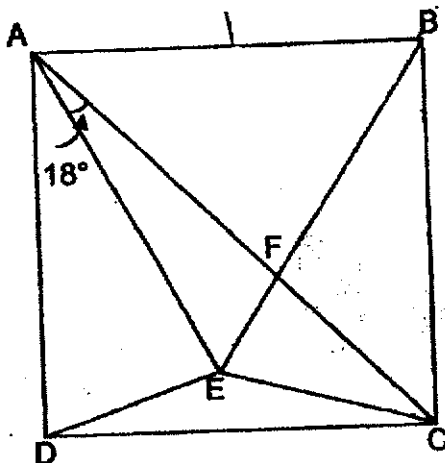

Ans: (a) _____ [2]

(b) _____ [2]

15. The figure consists of a square, a big semicircle, 2 small semicircles and a quarter circle. O is the centre of the big semicircle and quarter circle. The diameter of the big semicircle is 4 times the radius of the small semicircle. The length of OC is 8 cm.

(a) Find the diameter of the small semicircle.

(b) Find the perimeter of the shaded parts.

(Take $\pi = 3.14$.)

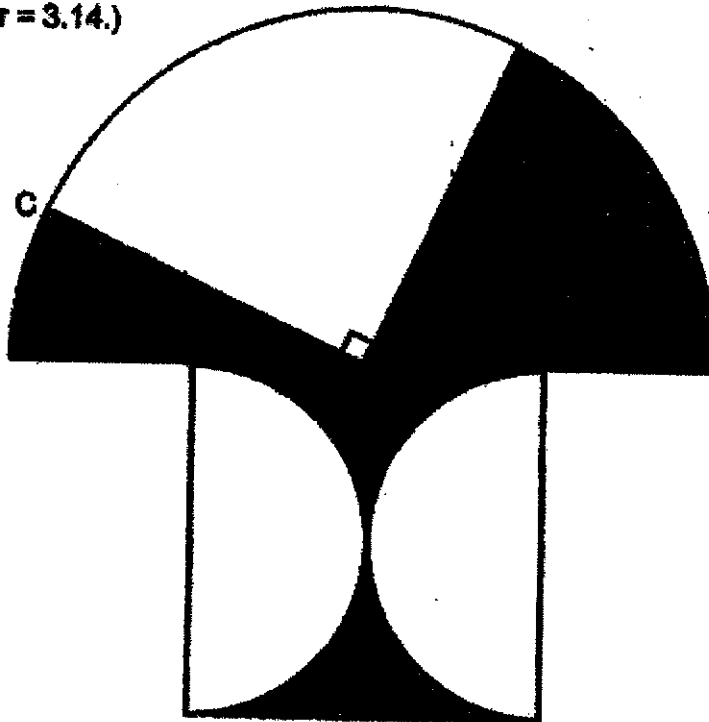

Ans: (a) _____ [1]

(b) _____ [3]

16. Mr Chew had 152 more mangoes than durians. He sold some mangoes and durians. The ratio of the number of mangoes sold to the number of durians sold is 3 : 1. The ratio of the number of durians sold to the number of durians left is 1 : 2. $\frac{2}{3}$ of the fruit left were mangoes.

- (a) How many durians did he have left?
(b) How many mangoes did he have at first?

Ans: (a) _____ [3]

(b) _____ [2]

17. Tammy sold some shoes and backpacks and received \$16 107. Tammy received \$663 more from selling the backpacks than from selling the shoes. Each backpack cost \$69 less than each pair of shoes. The number of pairs of shoes sold was $\frac{3}{5}$ of the number of backpacks sold.
- (a) How much money did she receive from selling the shoes?
- (b) How many backpacks did she sell?

Ans: (a) _____ [1]

(b) _____ [4]

End of Paper
Please check your work carefully ☺

ANSWER KEY

YEAR : 2021
LEVEL : PRIMARY 6
SCHOOL : RGPS
SUBJECT : MATHEMATICS
TERM : PRELIMINARY

BOOKLET A (PAPER 1)

Q1	3	Q2	2	Q3	2	Q4	3	Q5	1
Q6	1	Q7	1	Q8	4	Q9	1	Q10	3
Q11	4	Q12	4	Q13	2	Q14	3	Q15	3

BOOKLET B (PAPER 1)

Q16	$(3 \times 5 + 2) \times 4 = 68$	Q17	6.45pm
Q18	$42 \div 4 = \frac{42}{1} \times \frac{1}{4} = \frac{21}{2} = 10\frac{1}{2}$	Q19	191.54
Q20	$8 \times 4 = 32$ $5 \times 2 = 10$ $42 \div 7 = 6h$	Q21	$\frac{9}{10} - \frac{1}{5} = \frac{9}{10} - \frac{2}{10} = \frac{7}{10}$ $\frac{1}{2} = \frac{5}{10}$ $\frac{5}{10} + \frac{2}{10} = \frac{7}{10}$ $\frac{2}{10} = \frac{1}{5}$
Q22	$108\text{cm} = 108\text{cm}$ $8 \times 6 = 48$ $108 - 48 = 60$ $60 \div 4 = 15 \text{ cm}$	Q23	$148 - 12 = 136$ $136 \div 2 = 68$ $68 \div 4 = 17$
Q24	96	Q25	$\angle Z = 180^\circ - 130^\circ - 38^\circ = 12^\circ$ $\angle Y = 180^\circ - 38^\circ - 38^\circ = 104^\circ$ $\angle X = 104^\circ - 12^\circ \times 4 = 104^\circ - 48^\circ = 56^\circ$
Q26	$50 \div 4 = 12$ $12 \times 3 = 36$ $12 \times 4 = 48$ $50 - 48 = 2$ $2 \times 0.95 = 1.9$ $36 + 1.9 = \$37.90$	Q27	$\frac{1}{2} \times 4 \times 9 = 18$ $18 - 12 = 6$ $9 \times 4 = 36$ $36 + 6 = 42 \text{ cm}^2$
Q28	$1h = 10 + 10 = 20$ $2h = 20 + 20 = 40$ $3h = 40 + 20 = 60$ ANS : 3h	Q29	$24 + 14 + 22 = 60$ $1200 \div 60 = \$20$

Q30	$3 + 2 + 2 + 4 + 16 = 27$ $\frac{6}{27} = \frac{2}{9}$		
-----	---	--	--

PAPER 2

Q1	$4800 - 3840 = 960$ $\frac{960}{4800} \times 100\% = 20\%$	Q2	a) April b) $150 - 120 = 30$ $190 - 165 = 25$ ANS : March
Q3	$\angle DEF = 180^\circ - 26^\circ - 98^\circ = 56^\circ$	Q4	$1u = 186$ $10u = 186 \times 10 = \$1860$
Q5	a) True b) Not possible to tell c) Not possible to tell	Q6	$100 \div 10 = 10$ $10 - 2 = 8$ $8 \times 2 = 16$ $16 + 16 = 32$ $128 \times 0.25 \times 0.25 \times \pi = 0.0625$ $\pi \times 128 = 8\pi$ $32 - 8\pi = 6.86 \approx 6.9m^2$
Q7	a) $\angle UTX = \angle SRT = 79^\circ$ $\angle XRQ = 180^\circ - 143^\circ = 37^\circ$ $\angle XQR = 180^\circ - 37^\circ - 79^\circ = 64^\circ$ b) $\angle SRV = 180^\circ - 79^\circ = 101^\circ$ $\angle SVR = 180^\circ - 101^\circ - 21^\circ = 58^\circ$	Q8	$15 - 2 = 13$ $13 \times 30 + 35 + 35 = 460$ $14 - 4 = 10$ $460 - 50 - 50 = 360$ $360 \div 9 = 40cm$
Q9	$7T = 0.21 + 0.21 = 0.42$ $1T = 0.42 \div 7 = 0.06$ $1V = 0.06 + 0.21 = 0.27$ $0.27 + 0.06 = 0.33$ $0.33kg = 330g$	Q10	a) 40% remaining $= 4.8 \times 40 = 192$ Percentage = $\frac{192}{1920} \times 100\% = 10\%$ b) 300% of remaining $= 1440$ 1% of remaining $= 1440 \div 300 = 48$ 4% of remaining $= 4.8 \times 4 = 19.2$ Salary = $19.2 \times 100 = \$1920$
Q11	a) B speed = $2 \times 60 = 120/min$ Diff = $120 - 110 = 10$ b) A earlier = 45min A printed in 45min	Q12	a) $14u = 56$ $1u = 56 \div 14 = 4$ Mon = $4 \times 31 = 124$ b) Total (wed - fri) $= 75 \times 3 = 225$

	$=45 \times 110 = 4950$ Time taken for B to print same no. = $4950 \div 10$ $=495$ $495\text{min} = 8\text{h } 15\text{min}$ ANS : 5pm		Fri = $4 \times 30 = 120$ Wed+Thurs = $225 - 120$ = 105 Thurs = $(105 - 1) \div 2$ =52
Q13	a) $X \text{ (at first)} = \frac{5}{8} \times 30 \times 10 \times 20 = 3750\text{cm}^3$ b) $Y = 15 \times 15 \times 15 = 3375$ $X \text{ (after)} = 3750 - 3375 = 375$ $375\text{cm}^3 = 0.375\text{L}$	Q14	a) $\angle EAB = 18^\circ + 45^\circ = 63^\circ$ $= \angle AEB$ $\angle ABE = 180^\circ - 63^\circ - 63^\circ = 54^\circ$ b) $\angle EBC = 90^\circ - 54^\circ = 36^\circ$ $\angle BCE = \frac{180^\circ - 36^\circ}{2} = 72^\circ$ $\angle ECD = 90^\circ - 72^\circ = 18^\circ$
Q15	a) Radius of big semicircle = 8cm Diameter of small semicircle = 8cm b) Circumference of small circle = $3.14 \times 8 = 25.12$ Arc of big = $\frac{1}{2} \times 3.14 \times 8 \times 2 = 25.12$ Arc of quadrant = $\frac{1}{4} \times 3.14 \times 8 \times 2 = 12.56$ $25.12 - 12.56 = 12.56$ $16 - 8 = 8$ Perimeter of shaded = $25.12 + 12.56 + 8 + 8 + 8 + 8 = 69.68\text{cm}$	Q16	a) $4u = 152$ $1u = 152 \div 4 = 38$ $2u = 38 \times 2 = 76$ b) $7u = 38 \times 7 = 266$
Q17	a) Cost of all = $(16107 + 663) \div 2 = 8385$ Cost of all S = $8385 - 663 = 7722$ b) $1u(s) = 7722 \div 3 = 2574$ $1u(b) = 8385 \div 5 = 1677$ $2574 - 1677 = 897$ $1u \text{ no.} = 897 \div 69 = 13$ $5u \text{ no.} = 13 \times 5 = 65$		

